

WHITE PAPER

Programming and Simulating Automated Fiber Placement (AFP) CNC Machines

Bill Hasenjaeger
CGTech
9000 Research Dr.
Irvine, California 92618

Special thanks to
ELECTROIMPACT

Programming and Simulating Automated Fiber Placement (AFP) CNC Machines

Bill Hasenjaeger
CGTech
9000 Research Drive
Irvine CA 92618

ABSTRACT

Most users of Computer Numerically Controlled (CNC) Automated Fiber Placement (AFP) machinery use off-line Numerically Controlled (NC) programming software supplied by the machine builder. This machine builder-supplied software only works with their specific machine, forcing manufacturers to implement multiple off-line NC programming products when using multiple brands or vintages of machines. The more mature CNC metal-cutting industry started the same way, but has now evolved into a clear separation and cooperation between independent software and machine suppliers. This has freed the end-user company to select the best machine for the job, while using one universal software application to create NC programs for a variety of machine brands or vintage. When combined with composite design software tools that specifically take into account AFP manufacturing requirements early in the product development cycle, engineering and manufacturing specifications are seamlessly transferred to the manufacturing process. This paper discusses the implementation and use of machine-independent off-line NC programming software as it applies to CNC fiber placement machines.

1. INTRODUCTION

Recent advancements in automated composite fabrication machines, commonly called Automated Fiber Placement (AFP), are generating much excitement – and with good reason. Driven mostly by aerospace, but with technology quickly transferring to other industries, productive automated composite lay-up machinery is becoming a reality. In the same way cutting speed in “centimeters per minute” is boasted by manufactures of high-speed CNC milling machines, manufactures of AFP machines promote composite material application rates of “kilograms per hour,” while often ignoring other significant process complexities that must be addressed in order to lay-up parts quickly. The parallels don’t end there however; just as Computer Aided Design (CAD) and Computer Aided Manufacturing (CAM) software must continually evolve with new machining techniques, the software for programming AFP machines must also evolve to handle advances in technology. Software that narrowly supports one brand, vintage, or model of AFP machine, quickly becomes inapplicable and obsolete.

Today’s automated composite layup machinery and software has many similarities with the state of the CNC metal-cutting industry of the 1950’s and 60’s. The technology is difficult to adopt for all but the largest manufacturers because of the high infrastructure costs. The process technology is complex and only understood by few. And, software is generally provided by machine

Copyright 2011 by CGTech. Published by Society for the Advancement of Material and Process Engineering with permission.

manufactures, with different software required for each machine brand, resulting in limited software implementation and advances. [1]

One goal of this paper is to help demystify the process of programming automated composite machinery by introducing the key components of machine independent off-line programming software. How hard could it be?

1.1 Audience

Any manufacturer involved with, or having an interest in, automated composite machinery.

1.2 Overview

This paper will provide a detailed synopsis of machine-independent off-line NC programming and simulation software as it applies to CNC fiber placement machines. Case studies will be used in discussing the implementation and use of this new software.

1.3 Background

Software developed for one specific brand of machine is only exposed to a small set of users of that machine, and limited to the requirements of that specific machine. Software that narrowly supports one brand, vintage, or model of AFP machine quickly becomes inapplicable and obsolete. And, software enhancements are driven by user requirements more than any other factor. Software exposed to a broad range of user experiences with varied processes and machine requirements, followed by listening to those users and synthesizing their comments, requirements, and requests, allows software developers to infer new product features generally applicable to the industry. Software developers do not invent the new features, at least not quickly or effectively, if left on their own or with a narrow band of user feedback. All users benefit from a broad implementation.

Off-line AFP programming software dedicated to a single machine brand is simply not economical or realistic for manufacturers. The costs and risk associated with implementing multiple off-line NC programming products has a tendency to lock them into a single machine supplier, rather than allowing them to select the best and most current machine for the job at hand. Universal CAD/CAM software that can be used on any CNC metal cutting machine is what allows a manufacturer the freedom to choose the best production metal-cutting solutions presently available without having to retrain his manufacturing engineers with new software each time. The inevitable appearance of new AFP machine suppliers makes the old approach unmanageable.

2. PROJECT OVERVIEW

Machine-independent off-line programming and simulation software for automated fiber-placement CNC machines consists of two components: programming and simulation. A composite software overview is presented in figure 1, illustrating how one off-line NC programming system can be used for all AFP machines. The off-line machine-independent programming system is shown in figure 1(A), the post-processor creates machine-specific code

for a given machine and NC controller in figure 1(B), and that machine-specific code is sent to the physical machine in figure 1(C).

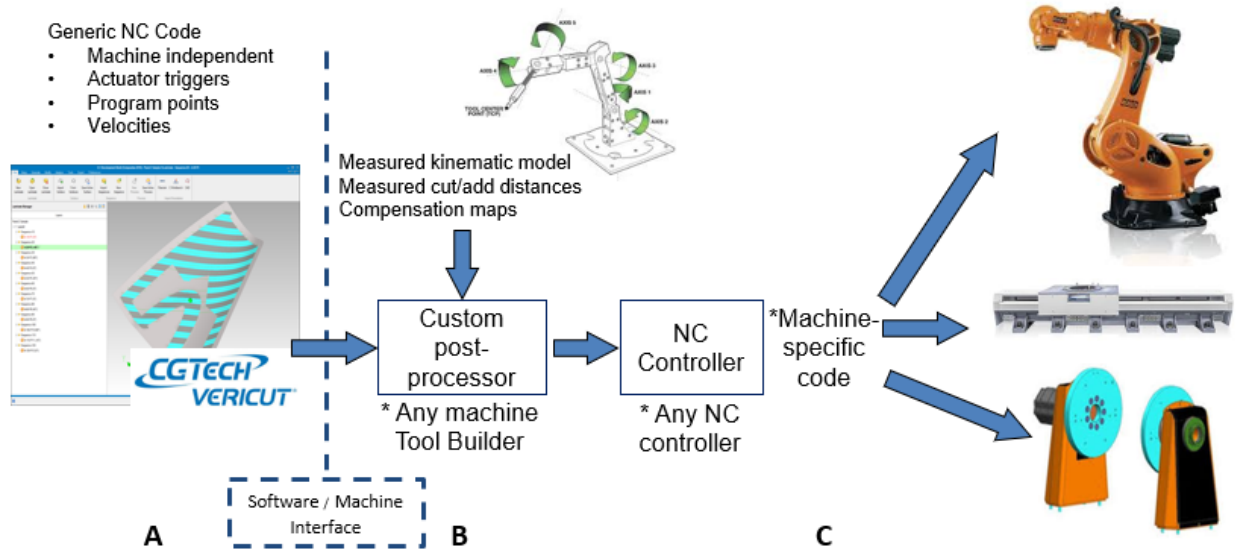

Figure 1. Composite software overview.

2.1 AFP Programming Software

A composite programming software overview is presented in figure 2. AFP Programming Software reads CAD models of the layup tool and ply boundary information that defines the laminate or ply stack and creates motion paths. This is illustrated by figure 2(A). The user then adds material and fills each ply boundary according to the user's engineering requirements and manufacturing standards. Layup motion paths are linked together in order to form specific layup. These two steps are shown together in figure 2(B). Once plies have been filled with material, these generated courses are then verified according to several producibility parameters, as shown in Figure 2 (C). Figure 3(a) shows ply boundaries and thickness that has been added to the layup tool. Figure 3(b) is zoomed in to show the individual tows of fiber tape, using colors to help differentiate adjacent courses. And finally, figure 3(c) shows the paths linked together in an NC program sequence. These ply paths are ready to be post-processed for the target machine. Multiple path trajectory methods are available to address specific engineering requirements and part topology, including: at a specified angle to one or more rosette axes, at specified angle to single/multiple guide curves, parallel to existing path, natural or adaptive steering. Sequences are then output as NC programs for the selected automated layup machine.

NC programs can contain partial, full or multiple plies and the user can analyze material limits prior to program creation. Paths or tows can be exported as CAD geometry for further engineering analysis of how the material is actually applied.

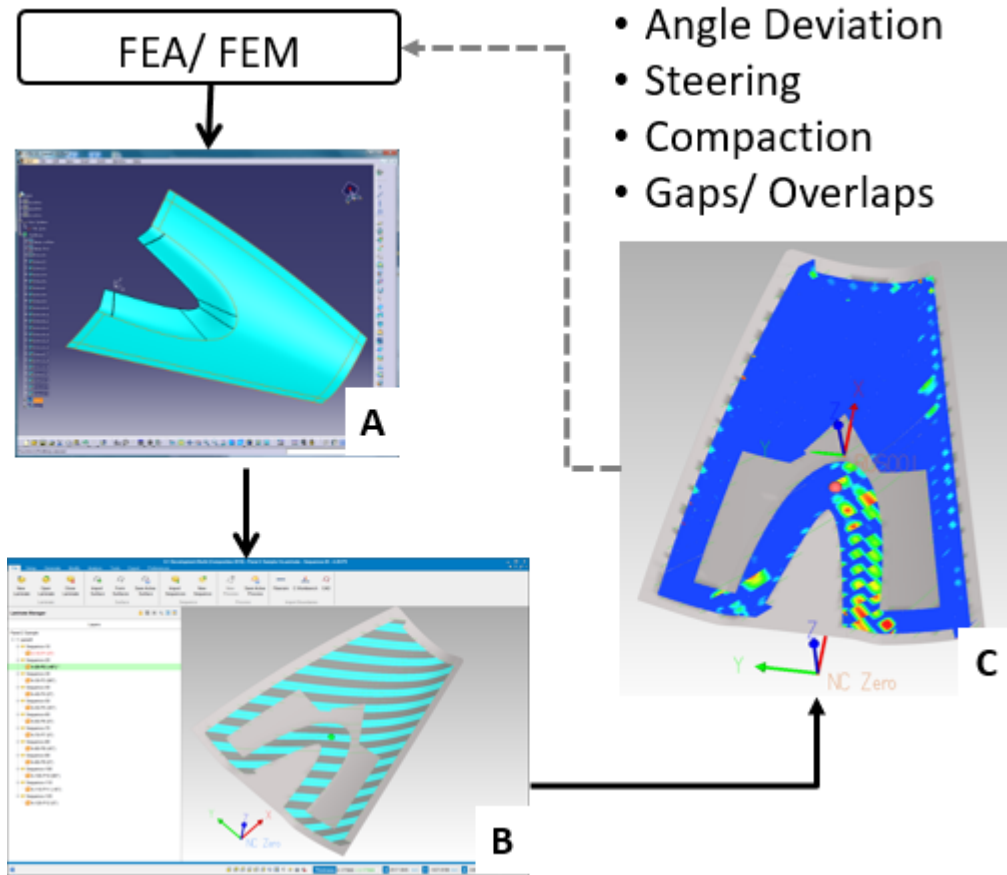

Figure 2. AFP programming software overview

Once a ply is filled with material, thickness is added to the tool surface in preparation for the next layer. As the plies of each layer are added, the tool surface is thickened to adjust for the added material, as shown in figure 2(b).

CAD layup tool models may be in one of several popular CAD formats, including: CATIA V5, NX, STEP, or ACIS .sat. Ply boundary geometry, consisting of 3D closed curves defining the layers used to construct the composite laminate, include the following formats: Fibersim Laminate Export, CATIA V5 Composite Workbench, Boeing MBD (either in CATIA V5 or exported in XML), and general 3D closed curves from one of the popular CAD file formats.

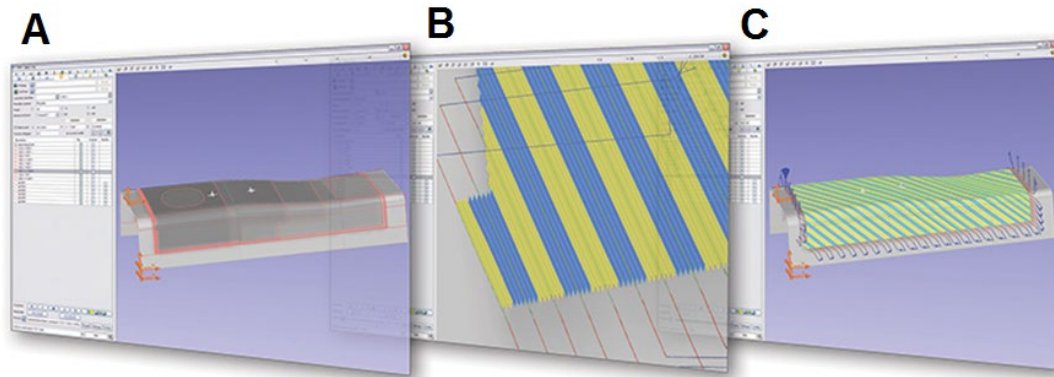

Figure 3. Three screenshots from AFP programming software.

2.2 AFP Simulation Software

An overview of AFP Simulation Software is presented in figure 4. After the design for manufacturing loop A-B-C is verified, CAD models and NC programs from this loop are imported into the simulation software (D). At this stage, machine joint limits, over-travels, collisions, and other process problems can be evaluated. It then simulates the sequence of NC programs on a virtual machine. Material is applied to the layup form via NC program instructions in a virtual CNC simulation environment. NC program tow add/cut commands are read and acted-on to add or drop the simulated applied material. The simulated material applied to the form can be measured and inspected to ensure the NC program follows manufacturing standards and requirements. A report showing simulation results and statistical information can be automatically created. Once all checks have been passed, the program is sent to be used by the physical machine (E).

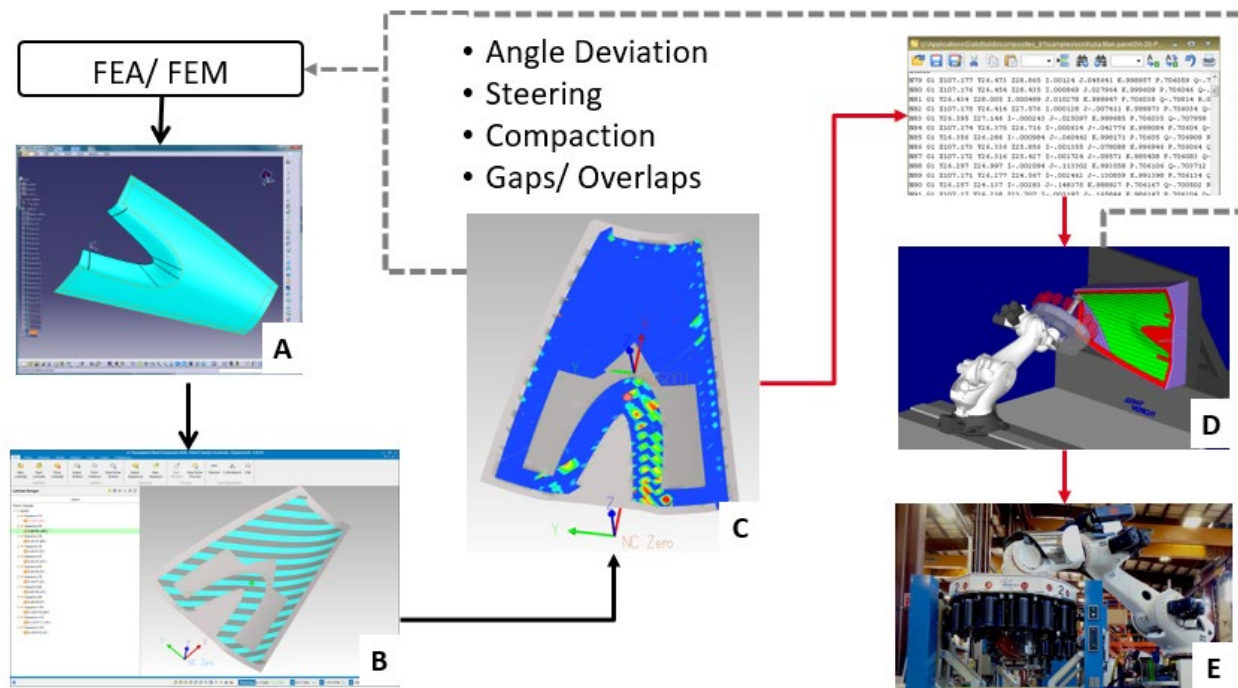

Figure 4. Overview of AFP Simulation Software

The purpose of simulation is to validate the CNC layout process. Machine kinematics and control emulation is user-configurable. All machine components can be checked for collisions and near-misses. The simulation is run directly from International Organization for Standardization (ISO) NC programs and tow material is applied by NC program commands (commonly referred to as “G-codes”).

At any point during the simulation the user can measure applied material: gap/lap; steering and roller conformance; thickness; and more.

3. CASE STUDIES

Most features incorporated in any commercial software product have been driven by customer-requested enhancements. As such, it is appropriate to discuss technical advancement in composite programming and simulation software in the context of real-world usage of the software.

3.1 Background

For over 23 years, CGTech has been constantly improving its VERICUT suite of software for metal cutting. But it was in 2004 that CGTech thrust full speed into the world of composites, after being contacted by Boeing (a CGTech customer since 1989) to develop a program for AFP machine simulation for 787 fabrication. This project progressed in 2005 to include the development of a programming solution for AFP machines. [2]

3.2 First customer-initiated project

In 2006, Electroimpact was selected to supply Spirit Aerosystems with a multiple-machine AFP lay-up cell for the Boeing 787 fuselage section 41. The composite lay-up cell features multiple independent machines, each with automatic head changers, resulting in a high continuous lay-down rate, with no head-service downtime. An Electroimpact AFP head, similar to the one now being used at Spirit Aerostructures, is shown in figure 5. Electroimpact recognized that CGTech is very capable to provide machine-independent AFP programming and simulation software. Since then Electroimpact has been in a non-exclusive cooperation with CGTech to develop AFP programming and simulation software. Following multiple years of testing and development, this software is being used by Spirit Aerosystems to program the new Electroimpact AFP machines being installed. [3]



Figure 5. An Electroimpact AFP head, similar to the one now being used at Spirit Aerostructures to create the Boeing 787 fuselage section 41. (Image courtesy of Electroimpact)

3.2.1 Project details

VERICUT Composite Programming (VCP) and VERICUT Composite Simulation (VCS) are now being used to program and simulate the one-piece barrel aircraft fuselage layup on an Electroimpact multi-machine AFP fabrication cell shown in figure 6. This screenshot is only for illustration and does not show the actual fuselage section being manufactured at Spirit Aerostructures.

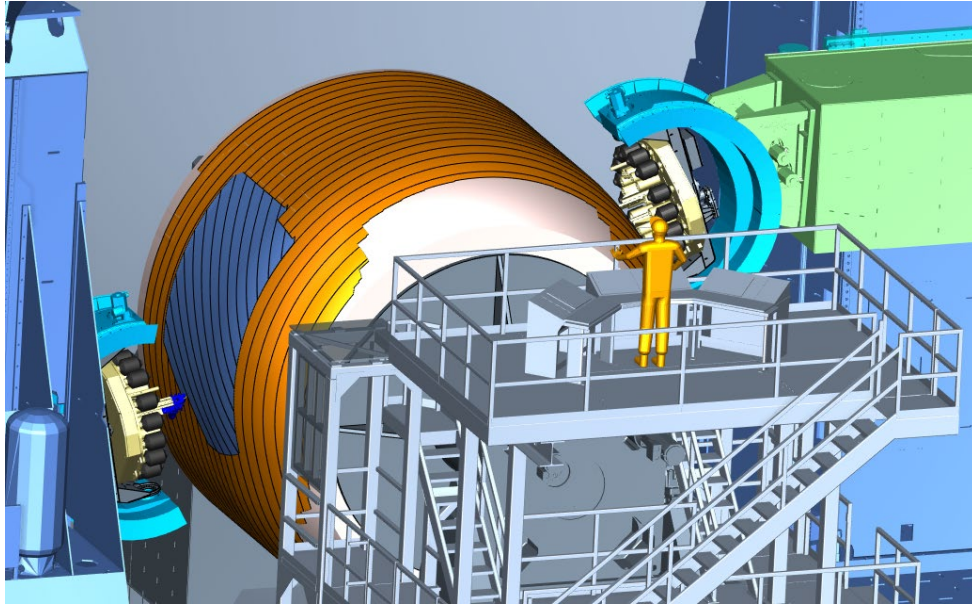

Figure 6. A screenshot from the simulation system being used to simulate the Electroimpact machines.

The machine is designed to meet future production rate requirements. A significant feature is that this machine uses a tape-head changer for continuous, high-speed operation. The machine is currently in production at the customer's factory.

3.3 Additional projects

Ever since the first offline AFP programming and simulation project was published, much interest has been expressed by AFP machine tool manufacturers and their customers. Several recent examples follow.

3.3.1 Cincinnati Viper 1200 AFP machine

The initial project involved simulating a jet aircraft duct layup on a Cincinnati Viper 1200 AFP machine. In 2008, the customer's initial tooling and path strategy created collisions between the tape-head and tooling.

As one would expect, it is very expensive to repair and redesign the damaged tape head and tooling. VERICUT off-line simulation is now used to predict collision and interference conditions. Collisions can now be detected among and between head, fixtures, and layup tools

Initial software delivery took place in December 2008, with final software delivery in Q2 2009. The software is currently in production, with ongoing collaboration and enhancements.

3.3.2 Electroimpact gantry design with removable rotisserie

Another project involves programming and simulating a flexible AFP machine for panels, mandrels, and "u-channel" structures shown in figure 7. The project uses an Electroimpact gantry design with removable rotisserie. There are four rotaries on the head with a total of eight

motion axes. As is typical with Electroimpact AFP machines, it employs an automatic head changer. This project completed mid-2009 with successful machine startup at the customer's site. [4]

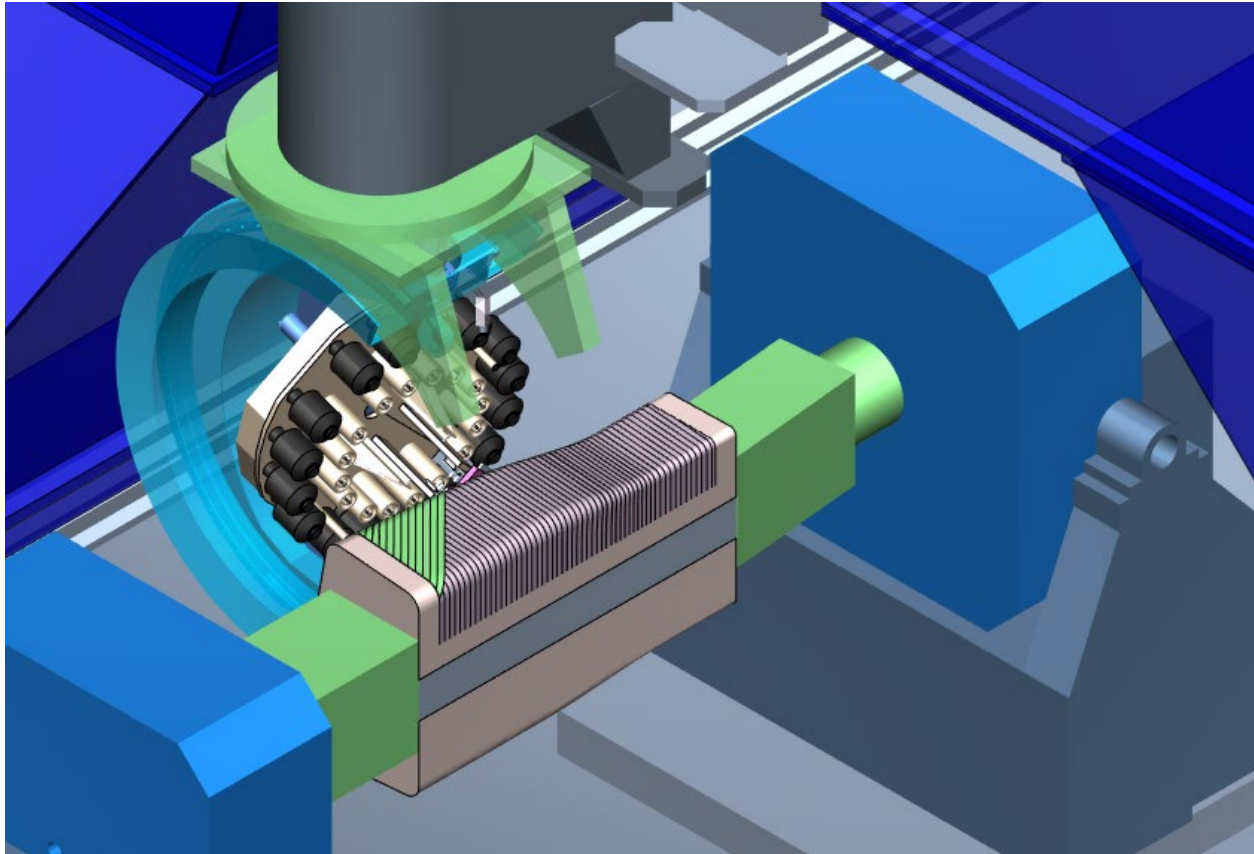

Figure 7 – Current programming and simulation project involving an Electroimpact gantry design with removable rotisserie.

3.3.3 Large U-Channel Horizontal AFP

MTorres announced in 2009 that it has been selected to supply automated fiber placement machines to build the Airbus A350 XWB wing front spar. This program marked the first time ever that AFP technology was used to manufacture this size of spars.

The MTorres AFP machine, similar to the one shown in Figure 8, has 6 machine axis and a part-side rotisserie for a total of 7 motion axis. The spar is 10 meters long and has a complex contour shape. Initial programming and simulation software was delivered in Q4 2009 and the machine has been delivered and accepted at the customer site.

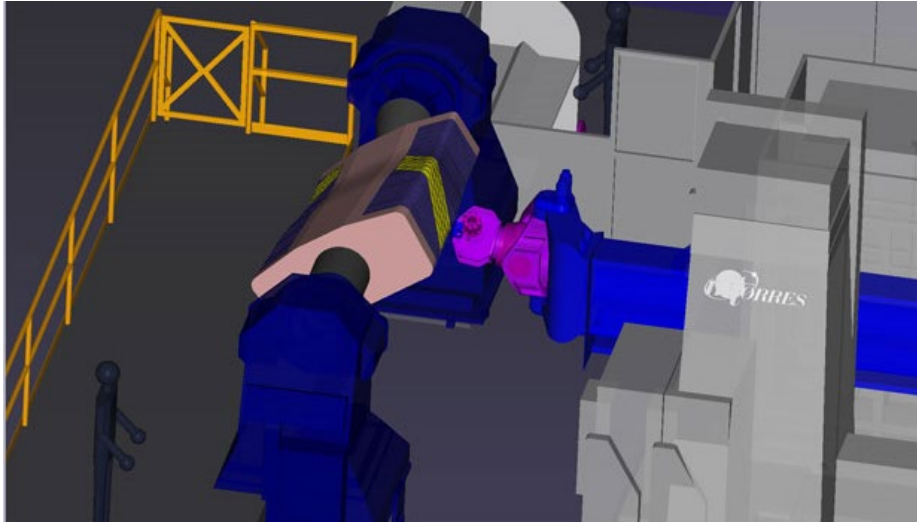

Figure 8 – An MTorres AFP machine creating two spars on one tool

3.3.4 Stringer Charge AFP

Another MTorres AFP machine is being used for wing stringer charge lay-up. This machine, shown in figure 9, has 4 motion axis. VERICUT was additionally enhanced to support programming and simulating an ultrasonic knife. The software and machine are in production now.

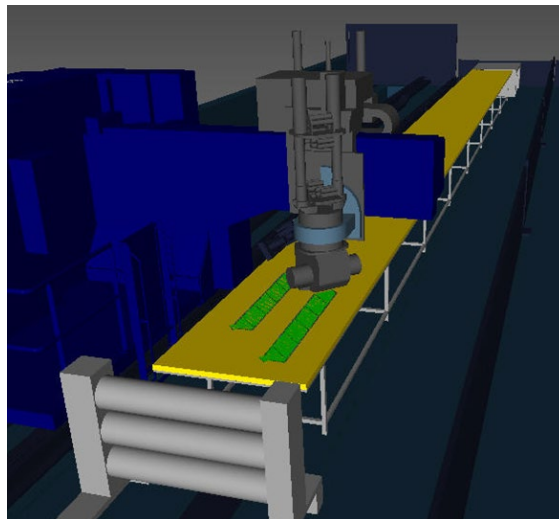

Figure 9 – A simulation of a MTorres AFP machine being used for wing stringer charge layup.

3.3.5 Kuka Robot with AFP head

Recent development of fiber placement using multiple Kuka robots involves two active projects. A Kuka robot with an Electroimpact AFP head is shown in figure 10. Requirements include the

ability to program and simulate complex curvature skin panels and fairings. The machine and software are currently in production.

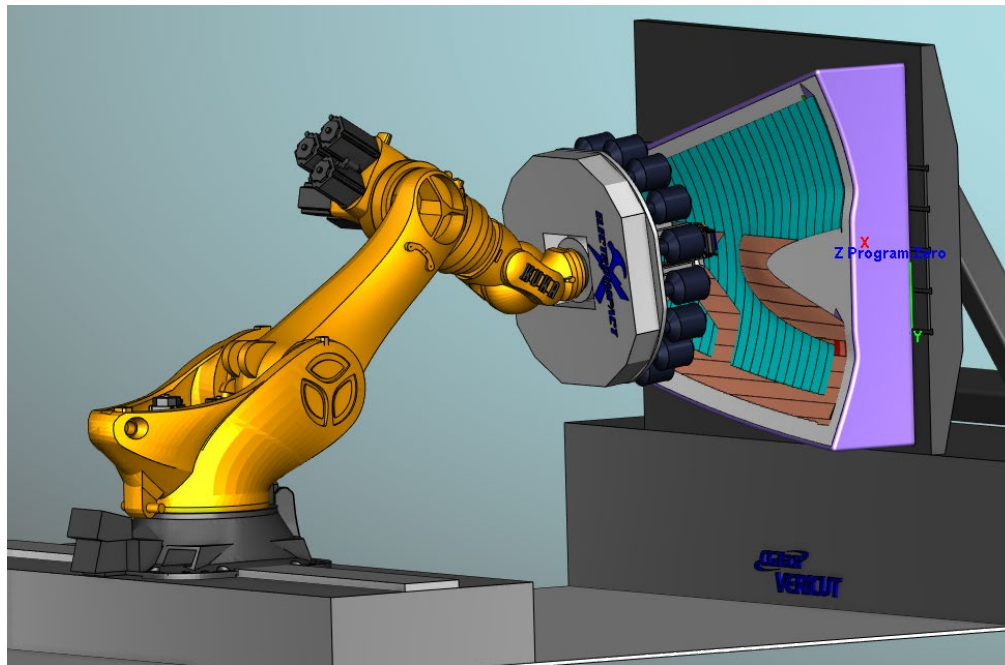

Figure 10 – A simulation rendering of a Kuka robot with Electroimpact AFP head.

3.3.6 Robot – Fokker

Fokker Aerostructures has also seen further development of the common industrial robot as an alternative option for the production of structural carbon fiber thermoplastic products.

Traditionally assembled by hand before curing, carbon fiber reinforced plastics (CFRPs) have seen a shift to gantry-type and large, finely-controlled AFP machines (as evidenced by the preceding case studies). To bring carbon fiber products into the mass market, manufacturers must reproduce results currently being achieved at the high end of the industry much more affordably. By developing a robotic system, Fokker hopes to establish a process featuring key proprietary technologies that can do the same job at a fraction of the cost, and with a smaller space penalty.

Fokker has been using CGTech's VERICUT product for metal cutting simulation since 1992 and began looking into its composite products in May 2009. As well as being affordable, processes carried out by the robot arm have to be highly repeatable in order to be suitable for production, as well as take advantage of its inherent flexibility. Although the working area of a robot is limited by its size to several meters, Fokker is synchronizing gangs of robots for fully scalable solutions to the lay-up of large parts, as shown in figure 11.

Upon proving the concept with its initial robotic fiber placement cell, Fokker commissioned CGTech to work on a larger cell with multiple tows. [5]

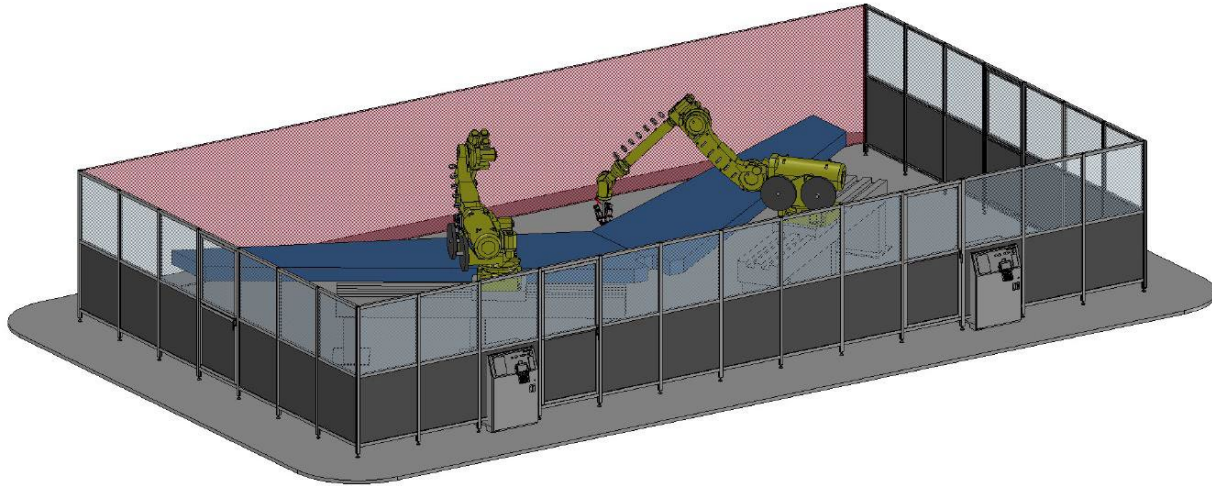

Figure 11 – Fokker Aerostructures is synchronizing gangs of robots for fully scalable solutions to lay-up large parts.

3.4 Integration with design

CGTech and VISTAGY, the developers of FiberSIM, have formed a strategic partnership to provide a solution for rapid design and manufacturing iterations, to optimize the development of composite structures produced by AFP machines. This integration enables designers to take into account AFP manufacturing requirements early on, and to seamlessly transfer composite design information from FiberSIM to VCP software for creating and validating CNC programs for AFP machines. By enabling more iterations, with faster and better feedback later in the development process, firms are better able to evaluate the tradeoffs between manufacturing complexity and cost. It also allows engineers to design specifically for the manufacturing process and take advantage of innovative uses of composite materials [6]. Ply boundaries defined in FiberSim software, shown in figure 12(a) are used during programming, and then transferred for simulation of the final part, as shown in figure 12(b).

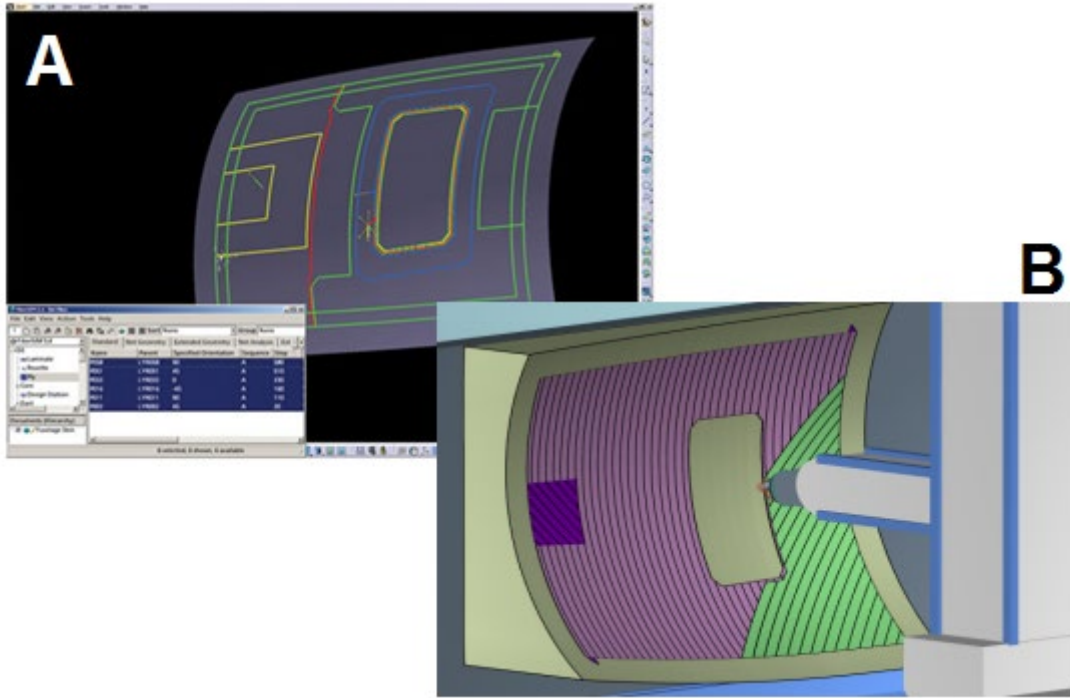

Figure 12. Ply boundaries defined in FiberSim software are used during programming and simulation.

4. CONCLUSIONS

Machine-independent software allows manufacturers to select the best machine for a specific part, family of parts, or manufacturing process, without having to introduce a different piece of software into the engineering process for each different brand of machine. With machine independent software the manufacturer learns and uses one application for programming and simulating all his AFP machines, regardless of the machine brand. This frees him up to make the best machine choice for his process.

Additionally, the broader the use of a software application, the more robust and universal that application becomes. Any software application with a limited or narrow focus tends to become stagnant, with infrequent updates and only small advances in technology.

Finally, machine tool companies are not commercial software companies. They are focused on advances in machine and materials technology, and rightly so. As a result, they tend to fall behind the curve on commercial computer hardware and software advances because it is not core to machine tool manufacturing.

The CNC metal cutting machine industry figured this out many years ago.

4.1 Prognostication

Many manufacturers are struggling to apply current AFP technology to complex high-curvature part shapes. It often seems as though the machine the customer has is not designed to meet the

necessary requirements. However it also appears there are new AFP machine technologies being developed to specifically apply material over complex shapes. Innovative NC programming approaches are needed to successfully and reliably fiber-place complex parts while achieving the structural requirements of the laminate.

The AFP industry is changing very quickly and there are a lot of smart and creative people involved in it. The solution to economically fiber-placing small and complex parts is critical to the success of AFP technology. The current complex process has to simplify and stabilize so that it is practical for 2nd and 3rd tier suppliers. Until that happens, AFP will remain a boutique manufacturing method only available to the highest-end products and companies -- not very far away from the research lab. Commercially available, machine-independent programming and simulation software is a step in the right direction (away from the lab), helping to de-mystify the AFP programming process and make it more approachable for smaller companies.

5. REFERENCES

1. Sloan, Jeff. "AFP/ATL design-to-manufacture: Bridging the gap." *High Performance Composites* May (2009): 42-46.
2. Oakham, Martin. "Laying down the future." *Metal Working Production*. November (2008): 70-71
3. Russell DeVlieg, Kyle Jeffries, Peter Vogeli "High-Speed Fiber Placement on Large Complex Structures" SAE International (2007): 4-5.
4. Peter Vogeli, Andy Pervis, Electroimpact Inc. "Composite Lamination with a Gantry Style Machine" SAE International (2009)
5. "Robots – the affordable alternative?" *Aerospace Manufacturing*. June (2010): 98-99.
6. "VISTAGY, CGTech announce fiber placement partnership" *CompositesWorld.com*. Gardner Publications, Inc. September (2008).